

International IOR Rectifier

12CWQ10FN

SCHOTTKY RECTIFIER

12 Amp



D-Pak (TO-252AA)

Major Ratings and Characteristics

Characteristics	12CWQ10FN	Units
$I_{F(AV)}$ Rectangular waveform	12	A
V_{RRM}	100	V
I_{FSM} @ tp = 5 μ s sine	330	A
V_F @6Apk, $T_J = 125^\circ\text{C}$ (per leg)	0.65	V
T_J range	-55 to 150	$^\circ\text{C}$

Description/Features

The 12CWQ10FN surface mount, center tap, Schottky rectifier series has been designed for applications requiring low forward drop and small foot prints on PC board. Typical applications are in disk drives, switching power supplies, converters, free-wheeling diodes, battery charging, and reverse battery protection.

- Popular D-PAK outline
- Center tap configuration
- Small foot print, surface mountable
- Low forward voltage drop
- High frequency operation
- Guard ring for enhanced ruggedness and long term reliability

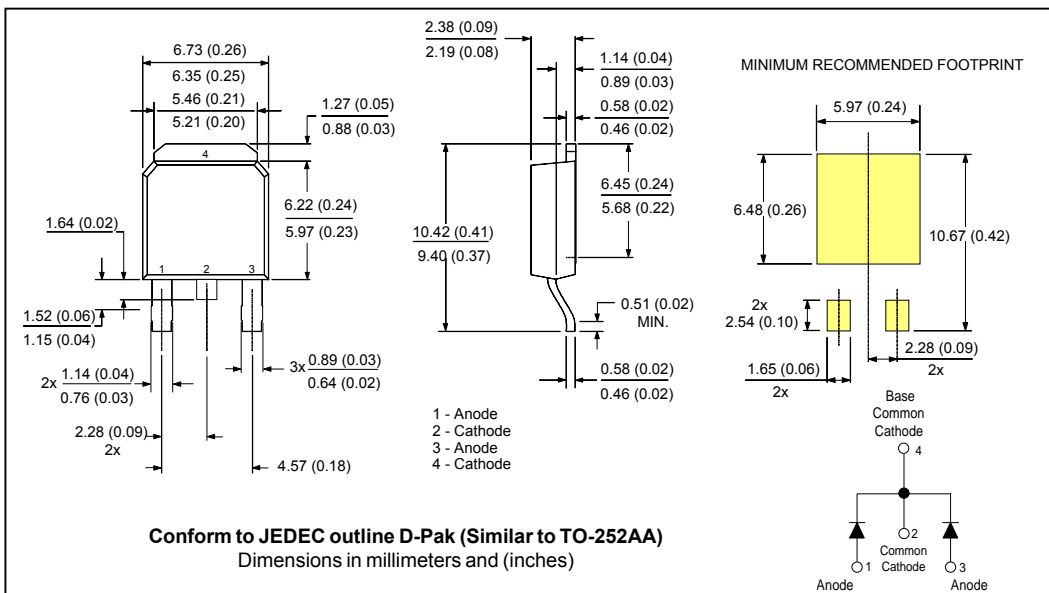

Voltage Ratings

Part number	12CWQ10FN
V_R Max. DC Reverse Voltage (V)	100
V_{RMM} Max. Working Peak Reverse Voltage (V)	

Absolute Maximum Ratings

$I_{F(AV)}$ Max. Average Forward Current* See Fig. 5 (Per Leg) (Per Device)	6	A	50% duty cycle @ $T_C = 135^\circ\text{C}$, rectangular waveform
	12		
I_{FSM} Max. Peak One Cycle Non-Repetitive Surge Current* See Fig. 7 (Per Leg)	330	A	5 μs Sine or 3 μs Rect. pulse 10ms Sine or 6ms Rect. pulse Following any rated load condition and with rated V_{RMM} applied
	110		
E_{AS} Non-Repetitive Avalanche Energy (Per Leg)	6	mJ	$T_J = 25^\circ\text{C}$, $I_{AS} = 0.5$ Amps, $L = 10$ mH
I_{AR} Repetitive Avalanche Current (Per Leg)	0.4	A	Current decaying linearly to zero in 1 μsec Frequency limited by T_J max. $V_A = 1.5 \times V_R$ typical

Electrical Specifications

Parameters	12CWQ...	Units	Conditions	
V_{FM} Max. Forward Voltage Drop (Per Leg) * See Fig. 1 (1)	0.80	V	@ 6A	$T_J = 25^\circ\text{C}$
	0.95	V	@ 12A	
	0.65	V	@ 6A	$T_J = 125^\circ\text{C}$
	0.78	V	@ 12A	
I_{RM} Max. Reverse Leakage Current (Per Leg) * See Fig. 2 (1)	1	mA	$T_J = 25^\circ\text{C}$	$V_R = \text{rated } V_R$
	4	mA	$T_J = 125^\circ\text{C}$	
$V_{F(TO)}$ Threshold Voltage	0.47	V	$T_J = T_J \text{ max.}$	
r_t Forward Slope Resistance	20.68	m Ω		
C_T Typ. Junction Capacitance (Per Leg)	183	pF	$V_R = 5V_{DC}$, (test signal range 100Khz to 1Mhz) 25°C	
L_S Typical Series Inductance (Per Leg)	5.0	nH	Measured lead to lead 5mm from package body	

(1) Pulse Width < 300 μs , Duty Cycle <2%

Thermal-Mechanical Specifications

Parameters	12CWQ...	Units	Conditions	
T_J Max. Junction Temperature Range (*)	-55 to 150	$^\circ\text{C}$		
T_{stg} Max. Storage Temperature Range	-55 to 150	$^\circ\text{C}$		
R_{thJC} Max. Thermal Resistance (Per Leg) Junction to Case (Per Device)	3.0	$^\circ\text{C/W}$	DC operation	* See Fig. 4
	1.5			
wt Approximate Weight	0.3(0.01)	g(oz.)		
Case Style	D-Pak	Similar to TO-252AA		

(*) $\frac{dP_{tot}}{dT_J} < \frac{1}{R_{th(j-a)}}$ thermal runaway condition for a diode on its own heatsink

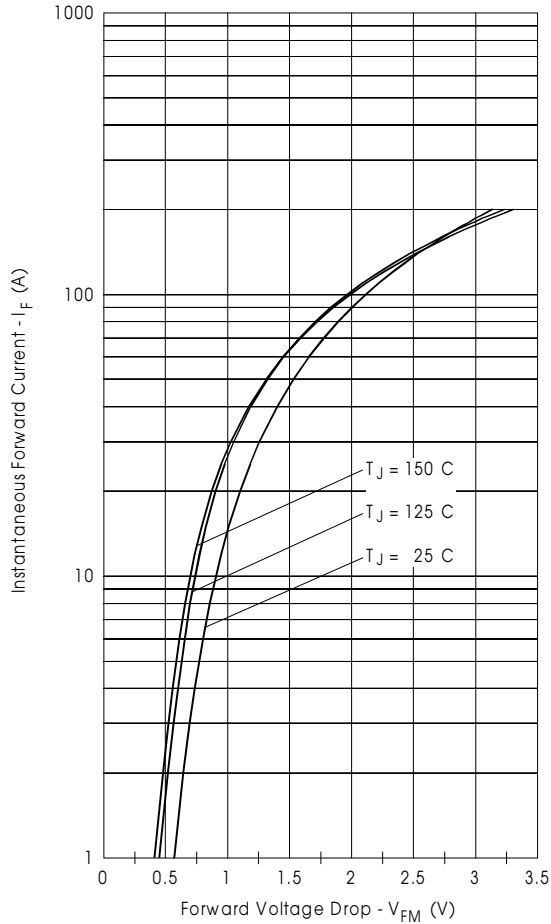

Fig. 1 - Max. Forward Voltage Drop Characteristics (Per Leg)

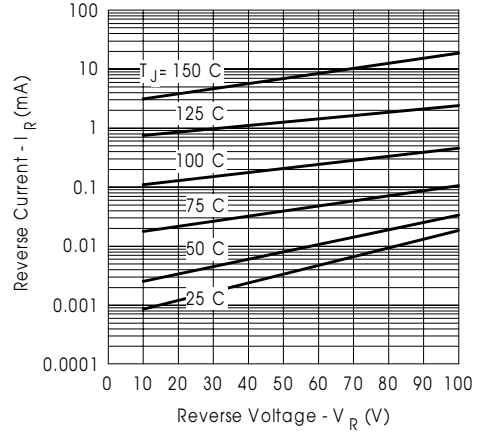

Fig. 2 - Typical Values Of Reverse Current Vs. Reverse Voltage (Per Leg)

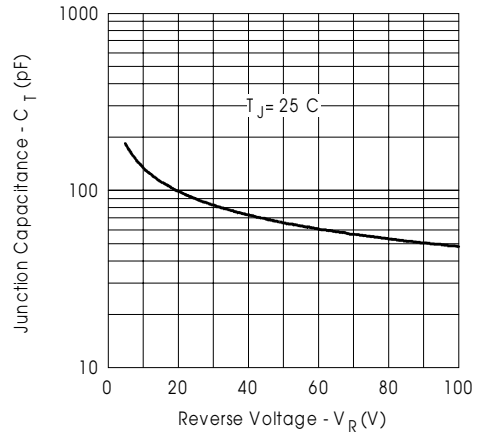

Fig. 3 - Typical Junction Capacitance Vs. Reverse Voltage (Per Leg)

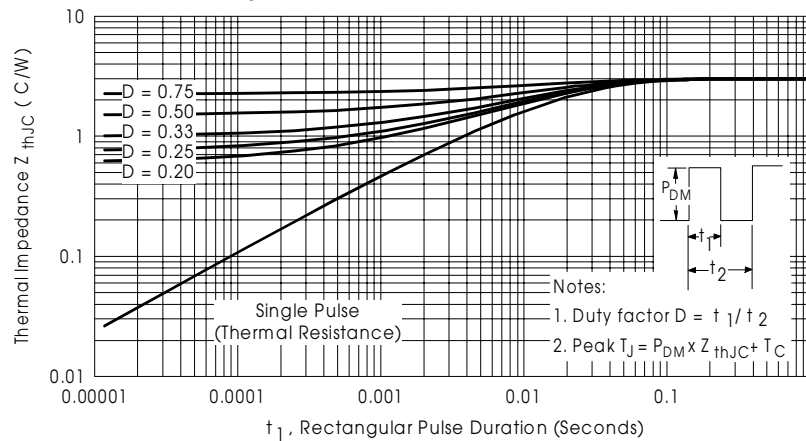

Fig. 4 - Max. Thermal Impedance Z_{thJC} Characteristics (Per Leg)

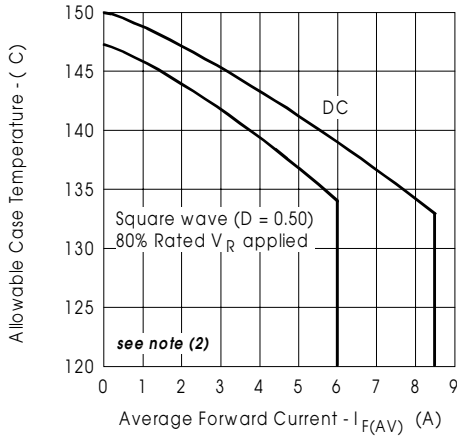

Fig. 5 - Max. Allowable Case Temperature Vs. Average Forward Current (Per Leg)

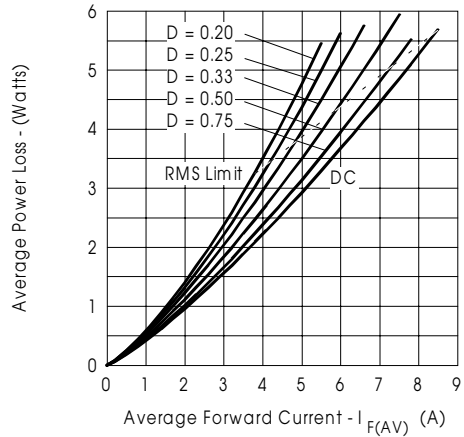

Fig. 6 - Forward Power Loss Characteristics (Per Leg)

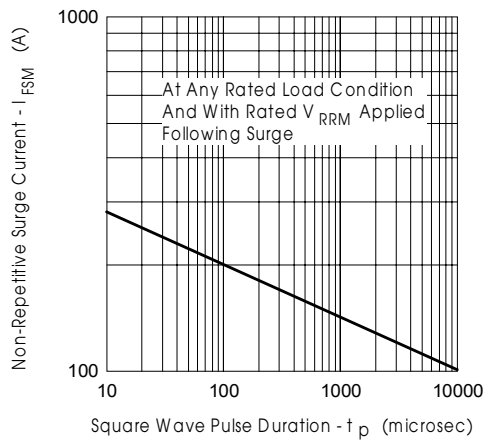

Fig. 7 - Max. Non-Repetitive Surge Current (Per Leg)

(2) Formula used: $T_c = T_j - (Pd + Pd_{REV}) \times R_{thJC}$;

Pd = Forward Power Loss = $I_{F(AV)} \times V_{FM} @ (I_{F(AV)} / D)$ (see Fig. 6);

Pd_{REV} = Inverse Power Loss = $V_{R1} \times I_R (1 - D)$; $I_R @ V_{R1} = 80\%$ rated V_R

Marking Information

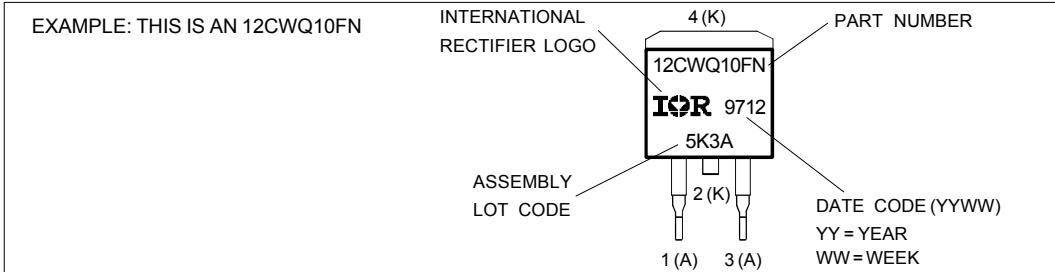

Tape & Reel Information

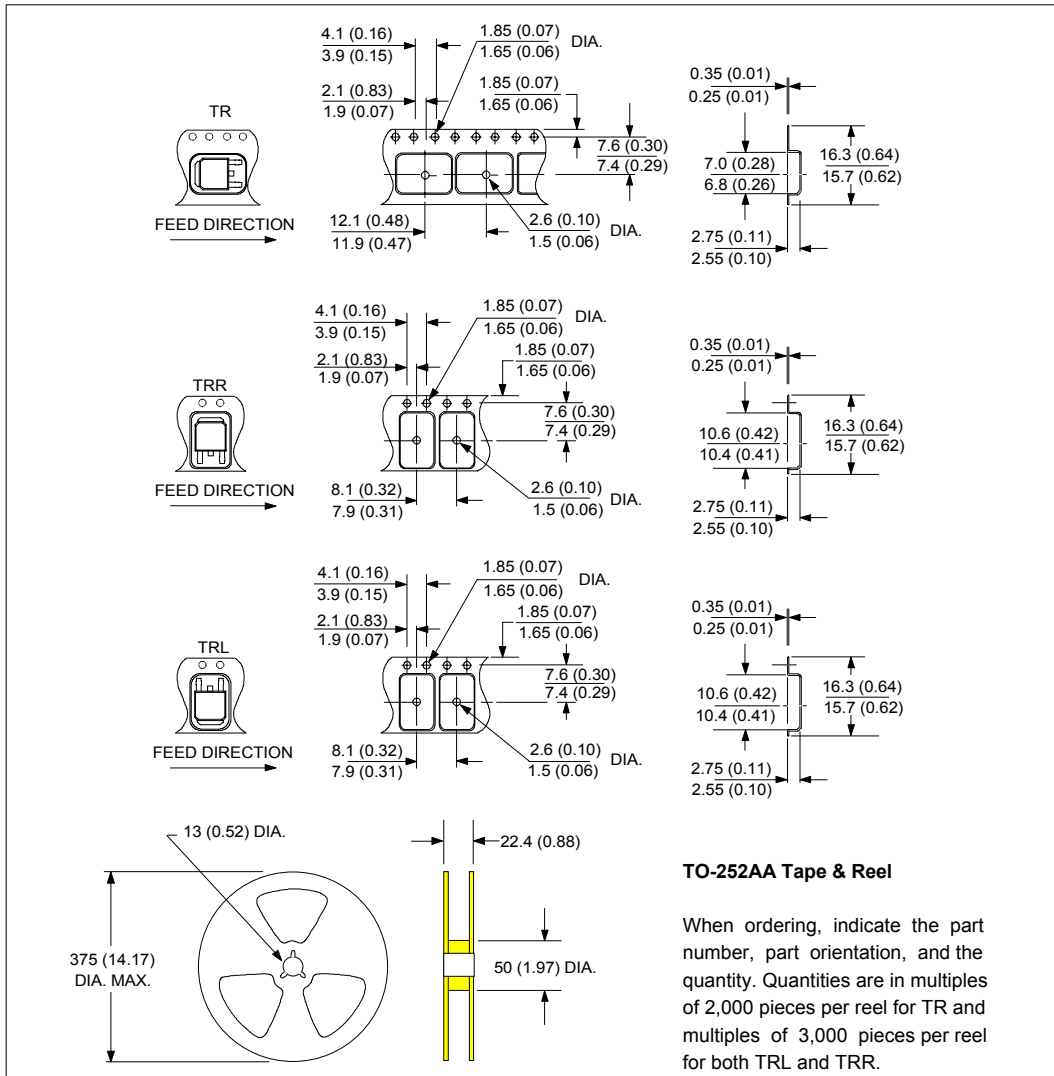

12CWQ10FN

Bulletin PD-20548 rev. D 02/02

International
IOR Rectifier

Data and specifications subject to change without notice.
This product has been designed and qualified for Industrial Level.
Qualification Standards can be found on IR's Web site.

International
IOR Rectifier

IR WORLD HEADQUARTERS: 233 Kansas St., El Segundo, California 90245, USA Tel: (310) 252-7105
TAC Fax: (310) 252-7309

Visit us at www.irf.com for sales contact information. 02/02