

Wire protector type terminal blocks / ED series

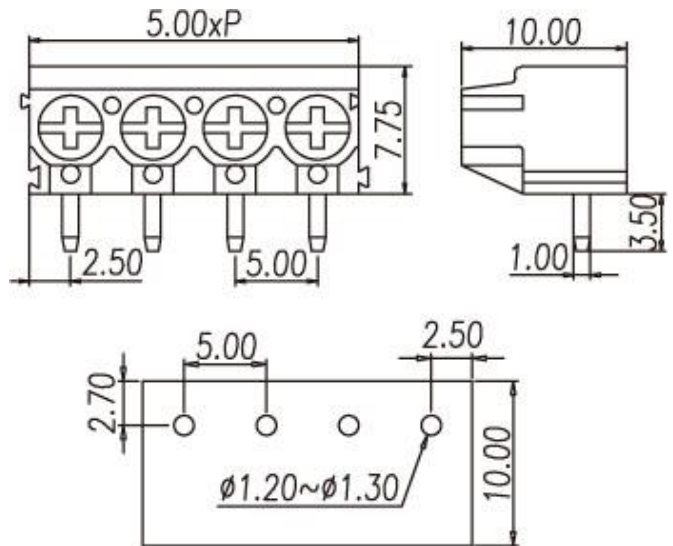

ED500R



Pitch: 5.00mm

Approval		
Technical Data	UL	IEC
Rated voltage	300V	250V
Rated current	16A	10A
Conductor cross-section, solid (AWG/ mm ²)	24~14 / 0.5~2.5	
Conductor cross-section, flexible (AWG/ mm ²)	24~14 / 0.5~2.5	
Rated surge voltage (UL/IEC/Max.)	1.6 / 2 / 4 KV	
Torque (N-m)	0.40	
Screw	M2.5	
Wire strip length	5~6mm	
Pole	Cat. No.	
02	ED500R-02P	
03	ED500R-03P	

TEL: +886-2-2908-0614

FAX: +886-2-2908-8549

E-mail: info@dinkle.com.tw