



NL Series

Wound Chip Inductors

APPLICATIONS

Microtelevisions, liquid crystal televisions, video cameras, portable VCRs, car radios, car stereos, thin tape radios, television tuners, mobile telephones, radio and other electronic devices.

OUTLINE

These revolutionary, highly reliable wound chip inductors for automatic mounting have been developed in response to the trend toward high density in electronic equipment.

With metal terminals and a body of heat resistant resin, these inductors offer many superior features.

FEATURES

Very strong solderability by flow soldering, soldering iron or wave soldering.

Highly accurate dimensions; can be mounted automatically.

Terminals are highly resistant to pull forces.

Highly resistant to mechanical shocks and pressure.

Highly reliable in environments of sudden temperature change and humidity. Super Q characteristics.

SHAPES AND DIMENSIONS

NL322522

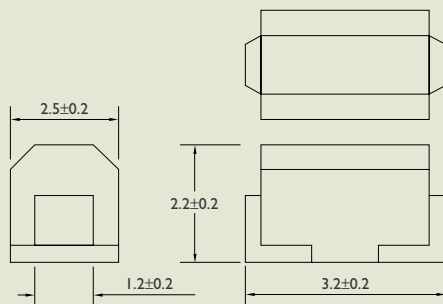

NL453232

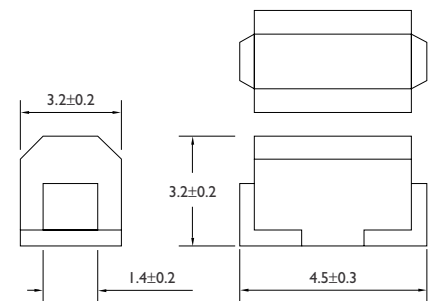

Dimensions : mm

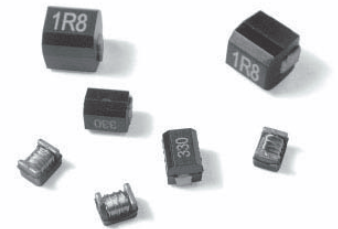

PRODUCT IDENTIFICATION

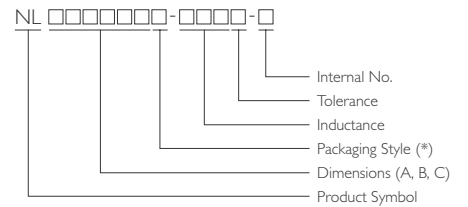

* T : Tape and Reel ; B : Bulk



ELECTRICAL CHARACTERISTICS NL322522 SERIES

PART NO.	INDUCTANCE (μ H)	TOLERANCE (\pm %)	Q Min.	TEST FREQUENCY (MHz)	SRF (MHz) Min.	DC RESISTANCE (Ω) Max.	IDC (mA) Max.
NL322522T-010K-S	0.010	10	15	100	2500	0.13	450
NL322522T-012K-S	0.012	10	17	100	2300	0.14	450
NL322522T-015K-S	0.015	10	19	100	2100	0.16	450
NL322522T-018K-S	0.018	10	21	100	1900	0.18	450
NL322522T-022K-S	0.022	10	23	100	1700	0.20	450
NL322522T-027K-S	0.027	10	23	100	1500	0.22	450
NL322522T-033K-S	0.033	10	25	100	1400	0.24	450
NL322522T-039K-S	0.039	10	25	100	1300	0.27	450
NL322522T-047K-S	0.047	10	26	100	1200	0.30	450
NL322522T-056K-S	0.056	10	26	100	1100	0.33	450
NL322522T-068K-S	0.068	10	27	100	1000	0.36	450
NL322522T-082K-S	0.082	10	27	100	900	0.40	450
NL322522T-R10K-S	0.10	10	28	100	700	0.44	450
NL322522T-R12K-S	0.12	10	30	25.20	500	0.22	450
NL322522T-R15K-S	0.15	10	30	25.20	450	0.25	450
NL322522T-R18K-S	0.18	10	30	25.20	400	0.28	450
NL322522T-R22K-S	0.22	10	30	25.20	350	0.32	450
NL322522T-R27K-S	0.27	10	30	25.20	320	0.36	450
NL322522T-R33K-S	0.33	10	30	25.20	300	0.40	450
NL322522T-R39K-S	0.39	10	30	25.20	250	0.45	450
NL322522T-R47K-S	0.47	10	30	25.20	220	0.50	450
NL322522T-R56K-S	0.56	10	30	25.20	180	0.55	450
NL322522T-R68K-S	0.68	10	30	25.20	160	0.60	450
NL322522T-R82K-S	0.82	10	30	25.20	140	0.65	450
NL322522T-1R0K-S	1.00	10	30	7.960	120	0.70	400
NL322522T-1R2K-S	1.20	10	30	7.960	100	0.75	390
NL322522T-1R5K-S	1.50	10	30	7.960	85	0.85	370
NL322522T-1R8K-S	1.80	10	30	7.960	80	0.90	350
NL322522T-2R2K-S	2.20	10	30	7.960	75	1.00	320
NL322522T-2R7K-S	2.70	10	30	7.960	70	1.10	290
NL322522T-3R3K-S	3.30	10	30	7.960	60	1.20	260
NL322522T-3R9K-S	3.90	10	30	7.960	55	1.30	250



ELECTRICAL CHARACTERISTICS NL322522 SERIES

PART NO.	INDUCTANCE (μ H)	TOLERANCE (\pm %)	Q Min.	TEST FREQUENCY (MHz)	SRF (MHz) Min.	DC RESISTANCE (Ω) Max.	IDC (mA) Max.
NL322522T-4R7K-S	4.70	10	30	7.960	50	1.50	220
NL322522T-5R6K-S	5.60	10	30	7.960	45	1.60	200
NL322522T-6R8K-S	6.80	10	30	7.960	40	1.80	180
NL322522T-8R2K-S	8.20	10	30	7.960	35	2.00	170
NL322522T-100K-S	10	10	30	2.520	30	2.10	150
NL322522T-120K-S	12	10	30	2.520	20	2.50	140
NL322522T-150K-S	15	10	30	2.520	20	2.80	130
NL322522T-180K-S	18	10	30	2.520	20	3.30	120
NL322522T-220K-S	22	10	30	2.520	20	3.70	110
NL322522T-270K-S	27	10	30	2.520	20	5.00	80
NL322522T-330K-S	33	10	30	2.520	17	5.60	70
NL322522T-390K-S	39	10	30	2.520	16	6.40	65
NL322522T-470K-S	47	10	30	2.520	15	7.00	60
NL322522T-560K-S	56	10	30	2.520	13	8.00	55
NL322522T-680K-S	68	10	30	2.520	12	9.00	50
NL322522T-820K-S	82	10	30	2.520	11	10.0	45
NL322522T-101K-S	100	10	20	0.796	10	10.0	40
NL322522T-121K-S	120	10	20	0.796	10	11.0	70
NL322522T-151K-S	150	10	20	0.796	8	15.0	65
NL322522T-181K-S	180	10	20	0.796	7	17.0	60
NL322522T-221K-S	220	10	20	0.796	7	21.0	50
NL322522T-271K-S	270	10	20	0.796	6	28.0	45
NL322522T-331K-S	330	10	20	0.796	5	34.0	40

Test Instruments : HP4286A RF Impedance Analyzer for L, Q, SRF
Digital Multimeter SC-7401 for RDC
HP4285A LF Impedance Analyzer for L, Q
Chen-Hwa 1061+Chen-Wiha 301A for IDC



ELECTRICAL CHARACTERISTICS NL453232 SERIES

PART NO.	INDUCTANCE (μ H)	TOLERANCE (\pm %)	Q Min.	TEST FREQUENCY (MHz)	SRF (MHz) Min.	DC RESISTANCE (Ω) Max.	IDC (mA) Max.
NL453232T-R10M-S	0.10	20	28	25.20	700	0.44	450
NL453232T-R12M-S	0.12	20	30	25.20	500	0.22	450
NL453232T-R15M-S	0.15	20	30	25.20	450	0.25	450
NL453232T-R18M-S	0.18	20	30	25.20	400	0.28	450
NL453232T-R22M-S	0.22	20	30	25.20	350	0.32	450
NL453232T-R27M-S	0.27	20	30	25.20	320	0.36	450
NL453232T-R33M-S	0.33	20	30	25.20	300	0.40	450
NL453232T-R39M-S	0.39	20	30	25.20	250	0.45	450
NL453232T-R47M-S	0.47	20	30	25.20	220	0.50	450
NL453232T-R56M-S	0.56	20	30	25.20	180	0.55	450
NL453232T-R68M-S	0.68	20	30	25.20	160	0.60	450
NL453232T-R82M-S	0.82	20	30	25.20	140	0.67	450
NL453232T-1R0K-S	1.00	10	50	7.960	100	0.50	450
NL453232T-1R2K-S	1.20	10	50	7.960	80	0.55	430
NL453232T-1R5K-S	1.50	10	50	7.960	70	0.60	410
NL453232T-1R8K-S	1.80	10	50	7.960	60	0.65	390
NL453232T-2R2K-S	2.20	10	50	7.960	55	0.70	380
NL453232T-2R7K-S	2.70	10	50	7.960	50	0.75	370
NL453232T-3R3K-S	3.30	10	50	7.960	45	0.80	355
NL453232T-3R9K-S	3.90	10	50	7.960	40	0.90	330
NL453232T-4R7K-S	4.70	10	50	7.960	35	1.00	315
NL453232T-5R6K-S	5.60	10	50	7.960	33	1.10	300
NL453232T-6R8K-S	6.80	10	50	7.960	27	1.20	285
NL453232T-8R2K-S	8.20	10	50	7.960	25	1.40	270
NL453232T-100K-S	10	10	50	2.520	20	1.60	250
NL453232T-120K-S	12	10	50	2.520	18	2.00	225
NL453232T-150K-S	15	10	50	2.520	17	2.50	200
NL453232T-180K-S	18	10	50	2.520	15	2.80	190
NL453232T-220K-S	22	10	50	2.520	13	3.20	180
NL453232T-270K-S	27	10	50	2.520	12	3.60	170
NL453232T-330K-S	33	10	50	2.520	11	4.00	160
NL453232T-390K-S	39	10	50	2.520	10	4.50	150
NL453232T-470K-S	47	10	50	2.520	10	5.00	140
NL453232T-560K-S	56	10	50	2.520	9	5.50	135
NL453232T-680K-S	68	10	50	2.520	9	6.00	130
NL453232T-820K-S	82	10	50	2.520	8	7.00	120
NL453232T-101K-S	100	10	40	0.796	8	8.00	110
NL453232T-121K-S	120	10	40	0.796	6	8.00	110
NL453232T-151K-S	150	10	40	0.796	5	9.00	105
NL453232T-181K-S	180	10	40	0.796	5	9.50	102
NL453232T-221K-S	220	10	40	0.796	4	12.00	100
NL453232T-271K-S	270	10	30	0.796	4	18.00	92
NL453232T-331K-S	330	10	30	0.796	3.5	20.00	85
NL453232T-391K-S	390	10	30	0.796	3	23.00	80
NL453232T-471K-S	470	10	30	0.796	3	26.00	62
NL453232T-561K-S	560	10	30	0.796	3	30.00	50
NL453232T-681K-S	680	10	30	0.796	3	40.00	50
NL453232T-821K-S	820	10	30	0.796	2.5	45.00	30
NL453232T-102K-S	1000	10	30	0.796	2.5	50.00	30



SHAPES AND DIMENSIONS NL565050 SERIES

Dimensions : mm

Shapes and Dimensions / Recommended PC Board Patterns

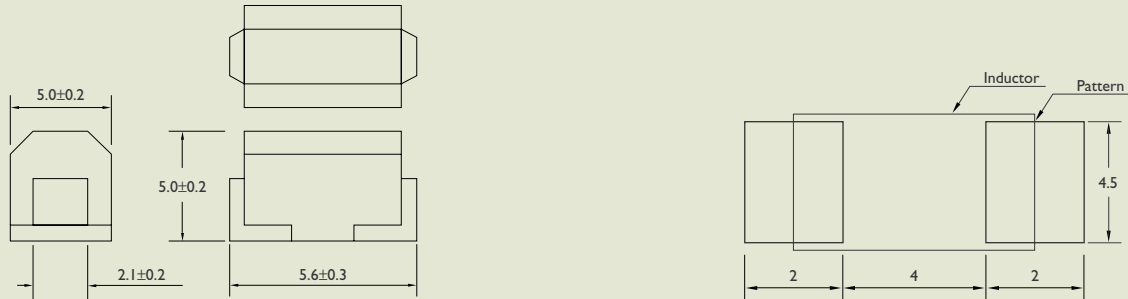

ELECTRICAL CHARACTERISTICS

Dimensions : mm

PART NO.	INDUCTANCE (mH)	TOLERANCE (±%)	Q Min.	TEST FREQUENCY (MHz)	SRF (MHz) Min.	DC RESISTANCE (Ω) Max.	IDC (mA) Max.
NL565050T-122J-S	1.2	5, 10	30	0.252	1.5	17	75
NL565050T-152J-S	1.5	5, 10	30	0.252	1.4	20	70
NL565050T-182J-S	1.8	5, 10	30	0.252	1.3	30	60
NL565050T-222J-S	2.2	5, 10	30	0.252	1.2	35	55
NL565050T-272J-S	2.7	5, 10	30	0.252	1.1	55	45
NL565050T-332J-S	3.3	5, 10	30	0.252	1	60	40
NL565050T-392J-S	3.9	5, 10	30	0.252	1	70	38
NL565050T-472J-S	4.7	5, 10	30	0.252	0.9	78	36
NL565050T-562J-S	5.6	5, 10	30	0.252	0.8	85	33
NL565050T-682J-S	6.8	5, 10	30	0.252	0.7	110	30
NL565050T-822J-S	8.2	5, 10	30	0.252	0.6	125	28
NL565050T-103J-S	10	5, 10	20	0.0796	0.5	150	25

Test Instruments : HP4286A RF Impedance Analyzer for L, Q, SRF
 HP4285A Precision LCR Meter for L, Q

Digital Multimeter SC-7401 for RDC
 Chen-Hwa 1061+Chen-Wha 301A for IDC



SHAPES AND DIMENSIONS NL201614 SERIES

Dimensions : mm

Ferrite body and wire wound construction provide highest current.

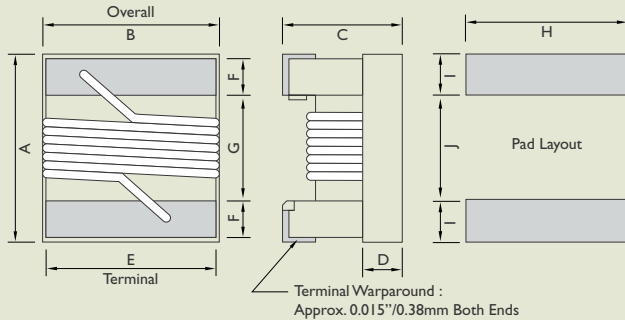

UNIT	A	B	C	D	E	F	G	H	I	J
	Max.	Max.	Max.	Ref.						
in	0.09	0.068	0.06	0.02	0.05	0.02	0.04	0.07	0.04	0.03
mm	2.29	1.73	1.52	0.51	1.27	0.51	1.02	1.78	1.02	0.76

ELECTRICAL CHARACTERISTICS

PART NO.	INDUCTANCE (μ H)	TOLERANCE (\pm %)	Q Min.	TEST FREQUENCY (MHz)	SRF (MHz) Min.	DC RESISTANCE (Ω) Max.	RATED CURRENT (mA) Max.	COLOR CODING
NL201614T-R12□-S	0.12	10/5	25	25.2	500	0.20	600	White
NL201614T-R15□-S	0.15	10/5	25	25.2	450	0.25	600	Black
NL201614T-R18□-S	0.18	10/5	25	25.2	410	0.30	570	Brown
NL201614T-R22□-S	0.22	10/5	25	25.2	350	0.35	550	Red
NL201614T-R27□-S	0.27	10/5	25	25.2	280	0.40	530	Orange
NL201614T-R33□-S	0.33	10/5	25	25.2	235	0.45	510	Yellow
NL201614T-R39□-S	0.39	10/5	25	25.2	210	0.50	490	Green
NL201614T-R47□-S	0.47	10/5	25	25.2	170	0.55	470	Blue
NL201614T-R56□-S	0.56	10/5	25	25.2	150	0.60	450	Violet
NL201614T-R68□-S	0.68	10/5	25	25.2	140	0.70	420	Gray
NL201614T-R82□-S	0.82	10/5	25	25.2	130	0.75	400	White
NL201614T-1R0□-S	1.00	10/5	15	7.96	115	0.80	350	Black
NL201614T-1R2□-S	1.20	10/5	15	7.96	95	0.90	325	Brown
NL201614T-1R5□-S	1.50	10/5	15	7.96	85	1.05	300	Red
NL201614T-1R8□-S	1.80	10/5	15	7.96	80	1.20	270	Orange
NL201614T-2R2□-S	2.20	10/5	15	7.96	75	1.40	250	Yellow
NL201614T-2R7□-S	2.70	10/5	15	7.96	70	1.60	230	Green
NL201614T-3R3□-S	3.30	10/5	15	7.96	60	1.80	210	Blue
NL201614T-3R9□-S	3.90	10/5	15	7.96	55	2.00	190	Violet
NL201614T-4R7□-S	4.70	10/5	15	7.96	45	2.40	170	Gray
NL201614T-5R6□-S	5.60	10/5	15	7.96	40	2.70	150	White
NL201614T-6R8□-S	6.80	10/5	15	7.96	36	3.20	140	Black
NL201614T-8R2□-S	8.20	10/5	15	7.96	33	3.60	120	Brown
NL201614T-100□-S	10.0	10/5	15	2.52	30	4.50	110	Red
NL201614T-120□-S	12.0	10/5	15	2.52	25	5.70	105	Orange
NL201614T-150□-S	15.0	10/5	15	2.52	33	6.50	90	Yellow
NL201614T-180□-S	18.0	10/5	15	2.52	21	7.00	85	Green
NL201614T-220□-S	22.0	10/5	15	2.52	20	8.00	78	Blue
NL201614T-270□-S	27.0	10/5	15	2.52	18	9.00	75	Violet
NL201614T-330□-S	33.0	10/5	15	2.52	17	10.0	70	Gray

When ordering, please specify tolerance and packaging code. Ex : NL201614T-100J-S

Tolerance : J = \pm 5% , K= \pm 10%

Packaging : Clear Tape and Reel (Standard)

L, Q, RDC : HP4286A

RDC : Digital Multimeter SC-7401

SRF : HP8753D / HP4286A

Operating Temperature Range : -25°C to +85°C



SHAPES AND DIMENSIONS NL252018 SERIES

Dimensions : mm

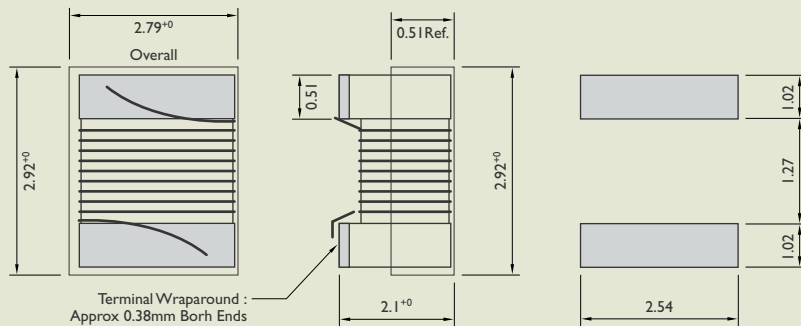

Color Coding

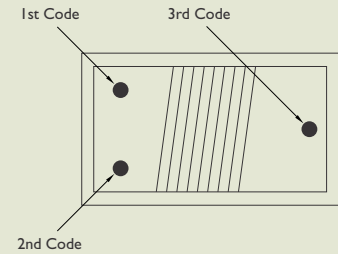

ELECTRICAL CHARACTERISTICS

PART NO.	INDUCTANCE (μ H)	TOLERANCE (\pm %)	Q Min.	TEST FREQUENCY (MHz)	SRF (MHz) Min.	DC RESISTANCE (Ω) Max.	IDC (mA) Max.	COLOR CODING		
								1 st	2 nd	3 rd
NL252018T-5N0□-S	0.005	10	10	100	3000	0.25	2000	Black	Green	Black
NL252018T-10N□-S	0.010	10	10	100	2500	0.25	1800	Brown	Black	Black
NL252018T-12N□-S	0.012	10	15	100	2400	0.26	1700	Brown	Red	Black
NL252018T-15N□-S	0.015	10	15	100	2300	0.28	1600	Brown	Green	Black
NL252018T-18N□-S	0.018	10	15	100	2200	0.30	1550	Brown	Gray	Black
NL252018T-22N□-S	0.022	5, 10	20	100	2100	0.35	1500	Red	Red	Black
NL252018T-27N□-S	0.027	5, 10	20	100	2000	0.40	1450	Red	Violet	Black
NL252018T-33N□-S	0.033	5, 10	30	100	1600	0.42	1400	Orange	Orange	Black
NL252018T-39N□-S	0.039	5, 10	35	100	1500	0.45	1350	Orange	White	Black
NL252018T-47N□-S	0.047	5, 10	35	100	1400	0.50	1300	Yellow	Violet	Black
NL252018T-56N□-S	0.056	5, 10	35	100	1300	0.60	1250	Green	Blue	Black
NL252018T-68N□-S	0.068	5, 10	35	100	1200	0.65	1240	Blue	Gray	Black
NL252018T-82N□-S	0.082	5, 10	35	100	1100	0.75	1230	Gray	Red	Black
NL252018T-R10□-S	0.10	5, 10	35	100	800	0.80	1220	Brown	Black	Brown
NL252018T-R12□-S	0.12	5, 10	30	25.2	700	0.30	900	Brown	Red	Brown
NL252018T-R15□-S	0.15	5, 10	30	25.2	550	0.35	900	Brown	Green	Brown
NL252018T-R18□-S	0.18	5, 10	30	25.2	500	0.40	850	Brown	Gray	Brown
NL252018T-R22□-S	0.22	5, 10	30	25.2	450	0.50	840	Red	Red	Brown
NL252018T-R27□-S	0.27	5, 10	30	25.2	425	0.55	830	Red	Violet	Brown
NL252018T-R33□-S	0.33	5, 10	30	25.2	400	0.60	820	Orange	Orange	Brown
NL252018T-R39□-S	0.39	5, 10	30	25.2	375	0.65	810	Orange	White	Brown
NL252018T-R47□-S	0.47	5, 10	30	25.2	350	0.68	800	Yellow	Violet	Brown



ELECTRICAL CHARACTERISTICS

PART NO.	INDUCTANCE (μ H)	TOLERANCE (\pm %)	Q Min.	TEST FREQUENCY (MHz)	SRF (MHz) Min.	DC RESISTANCE (Ω) Max.	IDC (mA) Max.	COLOR CODING		
								1 ST	2 ND	3 RD
NL252018T-R56□-S	0.560	5, 10	30	25.2	325	0.75	800	Green	Blue	Brown
NL252018T-R68□-S	0.680	5, 10	30	25.2	300	0.85	800	Blue	Gray	Brown
NL252018T-R82□-S	0.820	5, 10	30	25.2	260	1.0	800	Gray	Red	Brown
NL252018T-1R0□-S	1.000	5, 10	25	7.96	245	1.1	800	Brown	Black	Red
NL252018T-1R2□-S	1.200	5, 10	25	7.96	230	1.2	790	Brown	Red	Red
NL252018T-1R5□-S	1.500	5, 10	25	7.96	182	1.3	750	Brown	Green	Red
NL252018T-1R8□-S	1.800	5, 10	25	7.96	135	1.45	750	Brown	Gray	Red
NL252018T-2R2□-S	2.200	5, 10	25	7.96	105	1.55	750	Red	Red	Red
NL252018T-2R7□-S	2.700	5, 10	25	7.96	70	1.7	740	Red	Violet	Red
NL252018T-3R3□-S	3.300	5, 10	25	7.96	55	1.9	730	Orange	Orange	Red
NL252018T-3R9□-S	3.900	5, 10	25	7.96	48	2.1	700	Orange	White	Red
NL252018T-4R7□-S	4.7	5, 10	25	7.96	43	2.3	650	Yellow	Violet	Red
NL252018T-5R6□-S	5.6	5, 10	20	7.96	42	2.5	640	Green	Blue	Red
NL252018T-6R8□-S	6.8	5, 10	20	7.96	39	2.7	630	Blue	Gray	Red
NL252018T-8R2□-S	8.2	5, 10	20	7.96	36	3.05	600	Gray	Red	Red
NL252018T-100□-S	10	5, 10	15	2.52	33	3.5	680	Brown	Black	Orange
NL252018T-120□-S	12	5, 10	15	2.52	30	3.8	650	Brown	Red	Orange
NL252018T-150□-S	15	5, 10	15	2.52	26	4.4	500	Brown	Green	Orange
NL252018T-180□-S	18	5, 10	15	2.52	24	4.8	450	Brown	Gray	Orange
NL252018T-220□-S	22	5, 10	15	2.52	22	5.5	450	Red	Red	Orange
NL252018T-270□-S	27	5, 10	15	2.52	21	6.3	430	Red	Violet	Orange
NL252018T-330□-S	33	5, 10	15	2.52	20	7.1	380	Orange	Orange	Orange
NL252018T-390□-S	39	5, 10	10	2.52	18	9.5	330	Orange	White	Orange
NL252018T-470□-S	47	5, 10	10	2.52	17	11.1	300	Yellow	Violet	Orange
NL252018T-560□-S	56	5, 10	10	2.52	16	12.1	270	Green	Blue	Orange
NL252018T-680□-S	68	5, 10	10	2.52	15	16.6	250	Blue	Gray	Orange
NL252018T-820□-S	82	5, 10	10	2.52	13	19	200	Gray	Red	Orange
NL252018T-101□-S	100	5, 10	8	0.796	12	21	120	Brown	Black	Yellow

* UV Color : Blue / Core Color : Black

When ordering, please specify tolerance and packaging code. Ex : NL252018T-101J-S

Tolerance : □ J = 5% □ K = 10%

Packaging : Clear Tape and Reel (Standard)

L, Q, RDC : HP4287A

SRF : HP8753D / HP4291A RDC : Digital Multimeter SC-7401

Operating Temperature Range : -25°C to +85°C



TAPE DIMENSIONS

Dimensions : mm

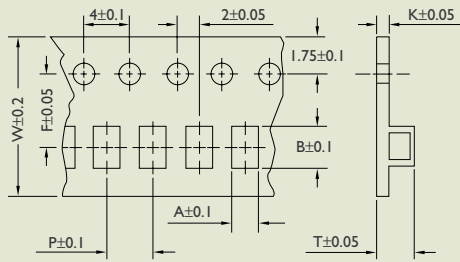

TYPE	A	B	T	W	P	F	K
NL201614	1.88	2.38	1.48	8	4	3.5	0.2
NL252018	2.61	2.83	2.25	8	4	3.5	0.25
NL322522	2.94	3.64	2.52	8	4	3.5	0.2
NL453232	3.64	5.14	3.6	12	8	5.5	0.3
NL565050	4.9	5.65	5.3	16.15	12.2	5.5	0.5

TAPE MATERIAL

Carrier Tape : Polystyrene

Cover Tape : Polyethylene

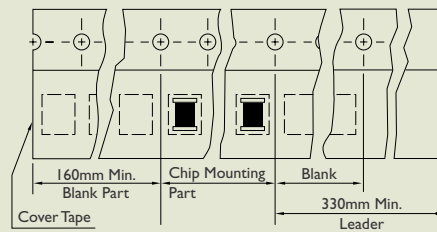

REEL DIMENSIONS

Dimensions : mm

Figure 1

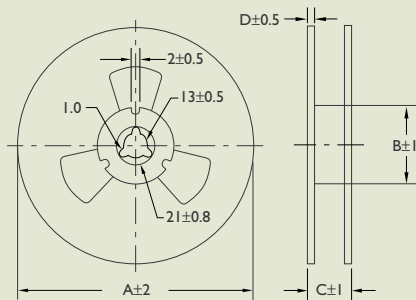
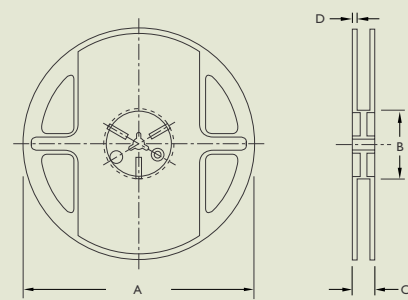

Figure 2



TYPE	FIGURE	A	B	C	D
NL201614	2	178	60	13	9
NL252018	2	178	60	12	1.5
NL322522	1	178	60	10	1.5
NL453232	1	250	80	14	1.5
NL565050	2	330	80	20	2

RECOMMENDED PATTERN

Dimensions : mm

NL45

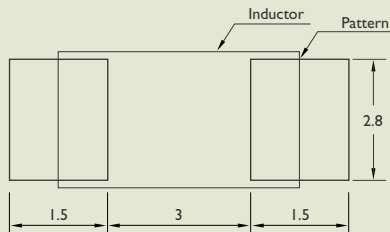

PACKAGING QUANTITY

TYPE	BULK	QUANTITY/REEL
NL201614	√	2500
NL252018	√	2000
NL322522	√	2000
NL453232	√	500
NL565050	√	1000



TYPICAL ELECTRICAL CHARACTERISTICS

Test Instruments : HP4291A Impedance / Material Analyzer

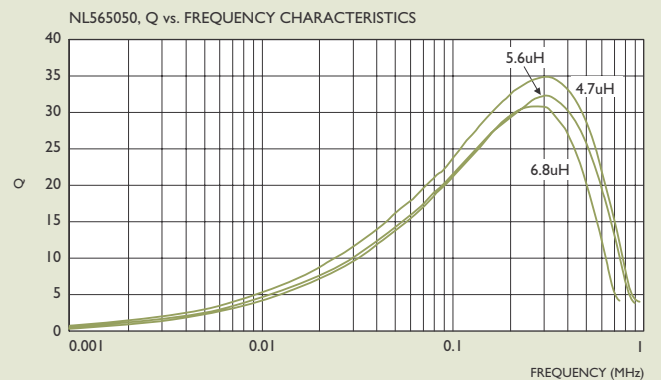
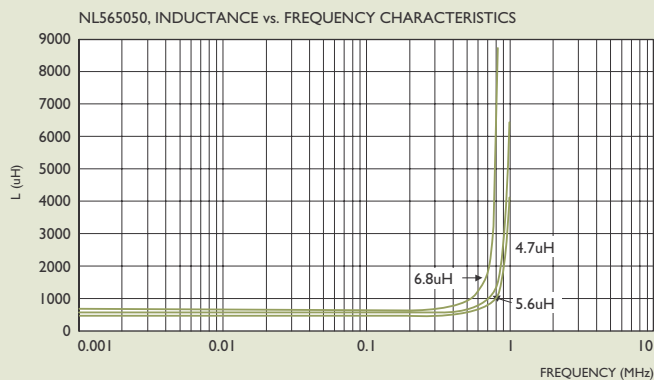
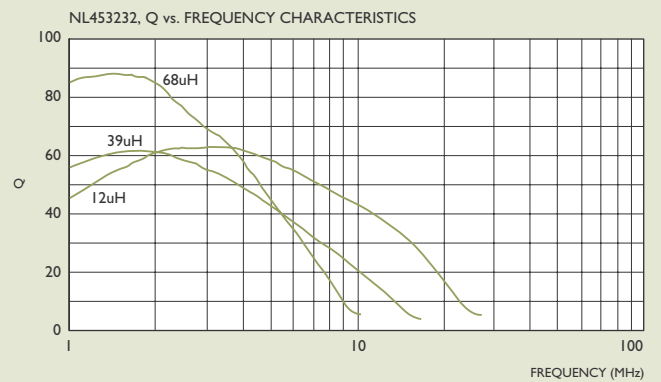
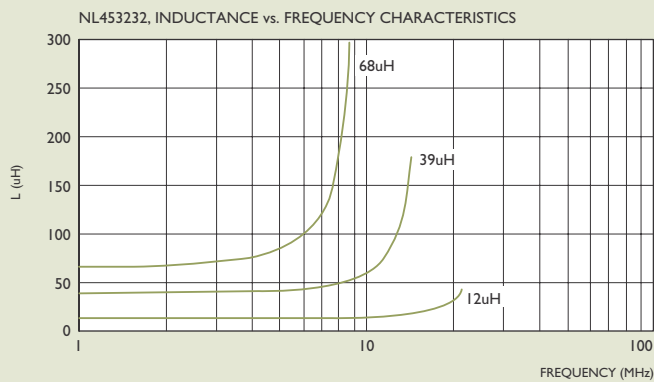
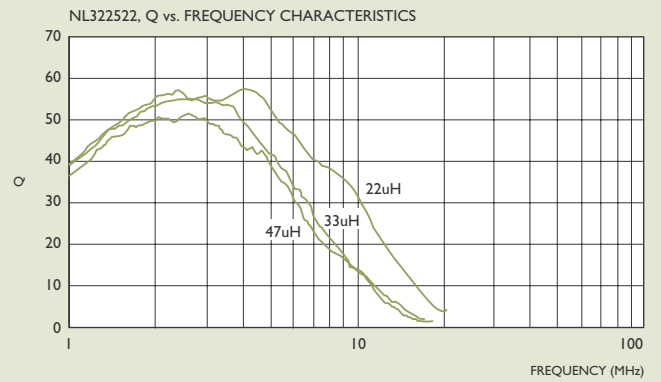
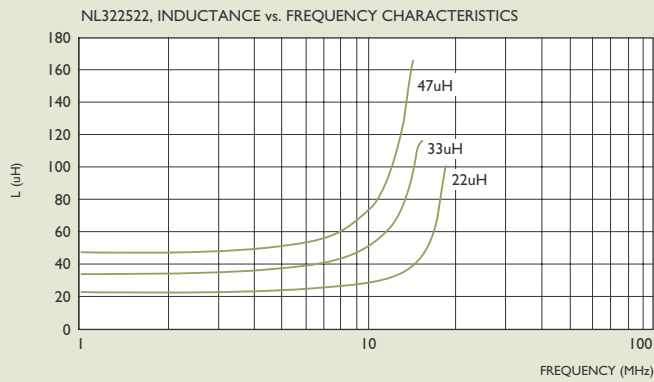
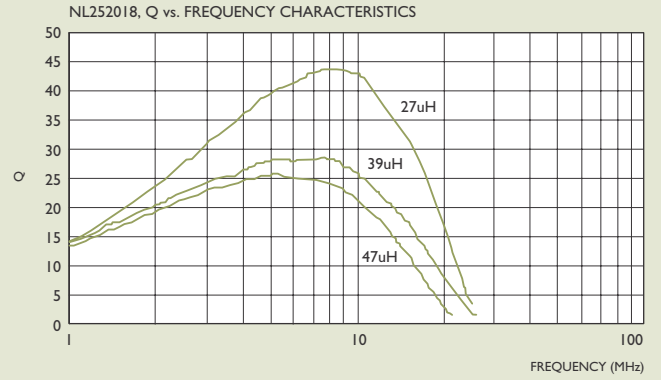
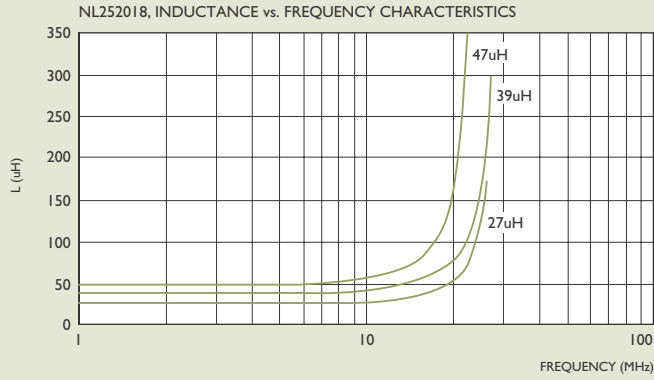



NL SERIES RELIABILITY TEST

I-1 MECHANICAL PERFORMANCE

NO.	ITEM	SPECIFICATION	TEST CONDITIONS
I-1-1	Vibration	Appearance : No Damage L Change : within $\pm 10\%$ Q Change : within $\pm 30\%$	Test device shall be soldered on the substrate. Oscillation Frequency : 10 to 55 to 10Hz for 1Min. Amplitude : 1.5mm Time : 2Hrs. for each Axis (X, Y & Z), Total 6Hrs.
I-1-2	Resistance to Soldering Heat	Appearance : No Damage	Pre-heating : 150°C, 1Min. Solder Composition : Sn/Pb = 63/37 Solder Temperature : $260 \pm 5^\circ\text{C}$ Immersion Time : 10 ± 1 Sec.
I-1-3	Solderability	The electrodes shall be at least 90% covered with new solder coating.	Pre-heating : 150°C, 1Min. Solder Composition : Sn/Pb = 63/37 Solder Temperature : $230 \pm 5^\circ\text{C}$ Immersion Time : 4 ± 1 Sec.

I-2 ENVIRONMENTAL PERFORMANCE

NO.	ITEM	SPECIFICATION	TEST CONDITIONS															
I-2-1	Temperature Cycle	Appearance : No Damage L Change : within $\pm 10\%$ Q Change : within $\pm 30\%$	One Cycle <table border="1"><thead><tr><th>Step</th><th>Temperature (°C)</th><th>Time (Min.)</th></tr></thead><tbody><tr><td>1</td><td>-25 ± 3</td><td>30</td></tr><tr><td>2</td><td>25 ± 2</td><td>3</td></tr><tr><td>3</td><td>85 ± 3</td><td>30</td></tr><tr><td>4</td><td>25 ± 2</td><td>3</td></tr></tbody></table> Total : 100 Cycles Measured after Exposure in the Room Condition for 24Hrs.	Step	Temperature (°C)	Time (Min.)	1	-25 ± 3	30	2	25 ± 2	3	3	85 ± 3	30	4	25 ± 2	3
Step	Temperature (°C)	Time (Min.)																
1	-25 ± 3	30																
2	25 ± 2	3																
3	85 ± 3	30																
4	25 ± 2	3																
I-2-2	Humidity Resistance		Temperature : $40 \pm 2^\circ\text{C}$ Relative Humidity : 90 ~ 95% Time : 1000Hrs. Measured after Exposure in the Room Condition for 24Hrs.															
I-2-3	High Temperature Resistance		Temperature : $85 \pm 3^\circ\text{C}$ Relative Humidity : 20% Applied Current : Rated Current Time : 1000Hrs. Measured after Exposure in the Room Condition for 24Hrs.															
I-2-4	Low Temperature Resistance		Temperature : $-25 \pm 3^\circ\text{C}$ Relative Humidity : 0% Time : 1000Hrs. Measured after Exposure in the Room Condition for 24Hrs.															